



DRL80M BE

09 291 01 08
1 (1)

M25x1.5 (2x)
M16x1.5 (1x)

IC

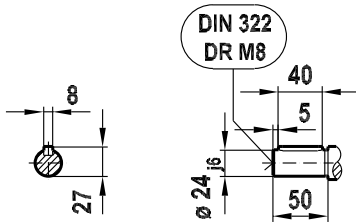
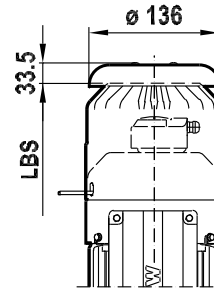
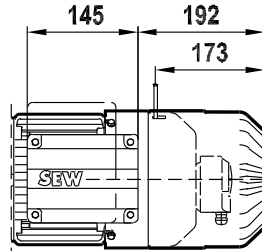
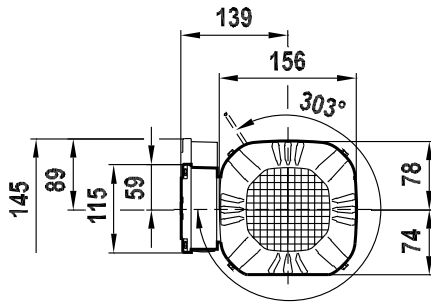

/FF (B5) FF165

/FT (B14) FT115

/Fl.. (B3)

